

UNICATION U3 USER GUIDE

The Real Live Multi - Mode
Analog / Digital
GPS Capability
Database Application
Live Site Data Transmissions

A NEW GENERATION TWO-WAY RADIO



Any Time, Any Where Unication is Ready to Serve You
If you have any requirement, please call our Toll Free Numbers: 888-657-2963.
www.unication.com



index

PREFACE	1
PART A : FUNCTION LIST	2
PART B : U3 OVERVIEW	5
1. PHYSICAL USER INTERFACE INTRODUCTION	5
2. TURNING THE UNICATION'S RADIO ON AND OFF	6
3. ADJUSTING THE SPEAKER VOLUME	6
4. SELECTING CHANNELS	6
5. STANDBY AND MAIN MENU FUNCTION	7
PART C : U3 RADIO INSTALLATION SETTING	11
1. OPTIONAL ACCESSORIES	11
1.1 STANDARD PACKAGE CONTENTS	11
2. HARDWARE INSTALLATION	12
2.1 CHARGING THE BATTERY	12
2.2 INSTALLING THE ANTENNA	13
2.3 INSTALLING THE BATTERY PACK	14
PART D : FUNCTIONS OPERATIONS	15
1. FUNCTION STATUS MENU	15
1.1 ENTER FUNCTION STATUS MENU	15
1.2 TO SWITCH FUNCTION STATUS ON/OFF	15
1.3 FUNCTIONS LISTED IN FUNCTION STATUS MENU	16
1.4 BLUETOOTH SETTING	17
2. CHANNEL SETTING	19
2.1 CHANNEL SETTING FUNCTION	19
2.2 FREQUENCY SETTING	29
2.3 SET RF IDENTITY	20
3. VOICE CALLS	21
3.1 MAKING CALLS	21
3.2 RECEIVING CALLS	22
3.3 CALL RECORDING	23
3.4 CALL OTHER CHANNEL	23
4. EMERGENCY CALL	25
4.1 SENDING AN EMERGENCY CALL	25
4.2 DISABLE THE EMERGENCY CALL	25
4.3 RECEIVING AN EMERGENCY CALL	25

5.	CALL ALERT	26
5.1	SENDING A CALL ALERT	26
5.2	RECEIVING A CALL ALERT	26
6.	CALL LOG AND EMERGENCY LOG	27
6.1	VIEWING A CALL LOG	27
6.2	VIEWING AN EMERGENCY LOG	27
7.	MESSAGES	28
7.1	ENTER THE MESSAGE FUNCTION MENU	28
7.2	CANNED MESSAGE	28
7.3	READING MESSAGES	30
8.	GPS FUNCTION	31
8.1	GPS ENGINE	31
8.2	GPS INFORM	31
8.3	GPS DISPLAY	32
9.	RADIO MONITOR	33
9.1	REMOTE MONITOR	33
10.	RADIO CHECK	34
10.	1RADIO CHECK	34
11.	MONITOR MODE	35
11.1	ENTER MONITOR MODE	35
11.2	USE MONITOR MODE	35
12.	OVER THE AIR FUNCTION (OTA)	36
12.1	CHANNEL SETTING BOX	36
12.2	SEND OVER THE AIR CONTROL MESSAGE	36
13.	CONTACTS	37
13.1	VIEWING CONTACTS	37
13.2	COMMUNICATE WITH CONTACTS	37
14.	IMAGE BOX	38
14.1	IMAGE BOX	38
15.	DATABASE FUNCTIONS	40
15.1	MISSING CAR SEARCH	40
15.2	MISSING PEOPLE SEARCH	40
15.3	SUSPECT SEARCH	41
16.	PERSONAL ASSISTANT	42
16.1	CALL AUTO REPLY	42
16.2	VOICE MEMO	43

17.	TOOLS	44
17.1	TOOL MENU	44
17.2	MEMORY	44
17.3	INFORMATION	44
18.	SYSTEM ALARM	45
18.1	RF HARDWARE ALARM SIGNALS (MCU)	45
18.2	OTHER ALARMS	45
PART F : WARRANTY AND SAFETY INFORMATION		46
1.	LIMITED WARRANTY AND SERVICE	46
2.	FCC PART 15 DECLARATION OF CONFORMITY	46
3.	SAFETY INFORMATION	46
4.	OPERATIONAL WARNINGS	51
5.	OPERATIONAL CAUTIONS	52
6.	OPERATIONAL CAUTIONS FOR INTRINSIC SAFE EQUIPMENT	53
7.	WARNINGS FOR RADIOS APPROVED AS INTRINSICALLY SAFE	53
8.	REPAIR	54

Preface

Thank you for purchasing UNICATION's U3 Radio. We believe that this professional two-way radio will provide you with a reliable communications solution for daily operations, emergencies and critical missions. The following is a function overview of the U3 2-way radio.

Support both Digital and Analog Simultaneously

The usage of narrow band digital two-way radios is a movement that is becoming more and more significant, but it is undoubtedly true that switching to a completely new digital radio system requires costly terminals and infrastructure upgrades. The Unication U3 radio series provides a phased upgrade solution, which ensures that every penny you invest now on analog portables will be an advancement to your digital system. The U3 can support both digital and analog signals in the same time, and it can help you reduce the enormous investment on systems during the transition time.

Advanced AES-256 Encryption even under Analog Systems

The Unication U3 radio series are intelligently designed for critical missions, where communications confidentiality is key for task security and success. The U3 radio includes AES Encryption, which is one of the most well developed and certified technologies in voice communication applications. It is the best choice for preventing eavesdropping when needing secure voice communications.

Additionally, the Unication Radio series is equipped with Secure digital voice (SDVOA) over existing analog repeaters or advanced Unication digital repeaters. Through Unication digital voice technology, Unication U3 radio series also promises a better noise rejection and preserves voice quality over a greater range than analog systems, especially at the farthest edges of the transmission range.

Live Site Photo- Instant Transmission of Images Via the two-way Radio System

A picture is worth a thousand words, especially in critical missions. The Unication U3 radio series has an advanced image messaging feature, with a 2" color display on portables which supports transmission and reception of color images such as crime scenes, mug shots, maps and so on.

GPS Location Map- Knowing the Locations of your Team Members

The key to successfully execute missions are time, and location information. How fast can your radio system react?

With a simple setup and migration-free system deployment, the Unication U3 Radio Series provides GPS locations on the 2" display map for all your rescue and tracking purposes.

To know further details about the U3 and enhance your user experience, please read this manual.

Thank you!

Part A: FUNCTION LIST

No.	Function	Description
U3 provides functions below. Some functions require programming processed to activate.		
1	Protocol Setting	Some U3 models support both digital and analog protocols; it automatically detects the type of signal and switches the receiving mode. Support Protocol Digital: P25 , P25Trunking, DMR, UniDMR Analog: 2 Tone, 5/6 Tone, CTCSS, CDCSS, MPT1327, CSQ, DVOA *R&R function can only be used under UniDMR Protocol.
2	Frequency Setting	Set Radio Frequency. VHF model supports 136~174MHz. UHF model supports 403-470Mhz, while the dual band 700/800 supports 763-870 MHz.
3	Contact Setting	Users can set different contact name to identify radio devices.
Voice Communication Functions		
1	Make Voice Calls	U3 supports voice functions below : a.Press PTT button in standby mode. b.Make all call, group call or private call in Contact. c.Press PTT button to reply or make call again in Hang Time. d.Automatically make calls. U3can be set to automatically transmit voice calls or be controlled by console remotely.
2	Receive Voice Call	Automatically detects the type of signal and switches the receiving mode.
3	Emergency Call	Provides an Emergency Call function. Once activated, the radio sends an emergency command on a pre-set channel.
4	Call Alert	If there was no response to voice call, users can leave a “Call Alert” notice for the receiver. This reminds the receiver to call back.
5	Call Log and Emergency Log	Provides logs of previously received calls and Alarms with contact information. These log lists can be used as a shortcut to access relative functions.

Part A: FUNCTION LIST

No.	Function	Description
Message Functions		
1	Text Message	Text Message: Supports the transmitting of canned messages and editable text messages.
2	Image Message	Supports transmitting image message with voice, text and GPS information.
3	Today	After turning on the radio, a Today menu reminds the user any unread message or event occurring today.
GPS Functions		
1	GPS Function	Supports GPS technology to provide location information.
2	GPS Display	GPS Display: Supports display of Location maps. (Map can be made and uploaded to U3 by the application software "Map Maker".)
3	GPS Inform	GPS Inform: Supports the reporting of GPS location information and the location display.
Frequency / Channel Functions		
1	Scan	The Scan function allows the radio detects the signals in the air. If the radio received signals, users can listen and talk back without switching channel.
2	Remote Monitor	The master radio can monitor a remote radio and listen to the ambient audio in any channel. The Radio Monitor function is set by using the PPS software.
3	Radio Check	This feature allows users to determine if team members are in or out of signal range. Note that if there is no response, team member's radio could be turned off, broken, or out of range.
4	Monitor Mode	Monitor Mode allows users to monitor signals nearby.
5	Contact	Radio contact information is stored under Contacts. This information is created by using the Product Programming Software (PPS). Please note the Contacts cannot be edited from the radio.
6	Zone	Users can group channels into a zone. Up to 16 channels per zone is supported, and channel capacity is 1024.

Part A: FUNCTION LIST

No.	Function	Description
Data Application		
1	Image Box	U3 can collect image messages and file them into the Image Box. Users can easily review images by using this function.
2	Database Functions	Users can use the Database Functions to view the records created and managed by the Database Maker software. There are total three categories of records: Stolen car, missing people and suspect.
3	Auto Reply	When this function is activated, the radio reminds the caller to leave a voice message when receiving private calls or call alerts.
4	Voice Memo	U3 supports voice memo recording.
Functions Setting		
1	Function Status	Set and check function status.
2	Settings	Set GPS, Bluetooth, Time and Date and LCD Backlight.
3	Tools	Set Alarm and check memory usage status.

Part: BU3 OVERVIEW

U3 overview includes appearance, LED indicator and icons on the screen.

1. PHYSICAL USER INTERFACE INTRODUCTION

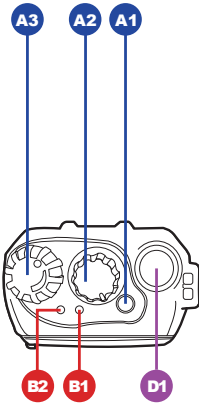
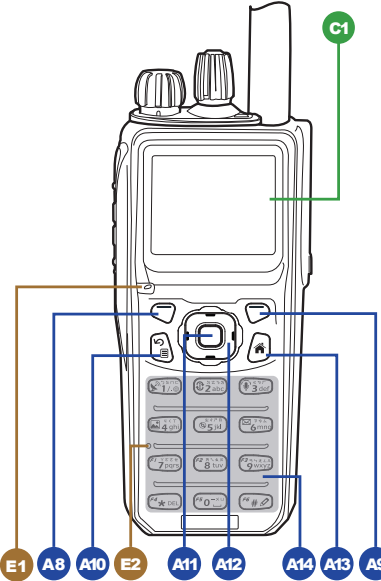
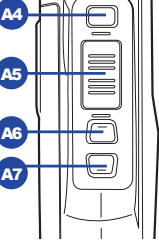
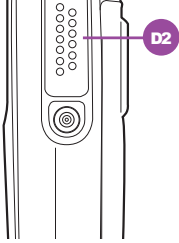
Description	Top Panel	Front Panel																														
<table border="1"> <thead> <tr> <th data-bbox="107 333 165 363">A</th> <th data-bbox="169 333 389 363">Buttons</th> </tr> </thead> <tbody> <tr><td>A1</td><td>Emergency Button</td></tr> <tr><td>A2</td><td>Channel Selector</td></tr> <tr><td>A3</td><td>Knob Volume Control and Power Switch Knob</td></tr> <tr><td>A4</td><td>Digital Voice Record (DVR) Button</td></tr> <tr><td>A5</td><td>PTT Button</td></tr> <tr><td>A6</td><td>Function Status Button</td></tr> <tr><td>A7</td><td>Keypad Lock Button</td></tr> <tr><td>A8</td><td>Left Soft Button</td></tr> <tr><td>A9</td><td>Right Soft Button</td></tr> <tr><td>A10</td><td>Back Button</td></tr> <tr><td>A11</td><td>Enter Button</td></tr> <tr><td>A12</td><td>4-Way Navigation Button</td></tr> <tr><td>A13</td><td>Home Button</td></tr> <tr><td>A14</td><td>12-Keypad (1 key is the Menu Button)</td></tr> </tbody> </table>	A	Buttons	A1	Emergency Button	A2	Channel Selector	A3	Knob Volume Control and Power Switch Knob	A4	Digital Voice Record (DVR) Button	A5	PTT Button	A6	Function Status Button	A7	Keypad Lock Button	A8	Left Soft Button	A9	Right Soft Button	A10	Back Button	A11	Enter Button	A12	4-Way Navigation Button	A13	Home Button	A14	12-Keypad (1 key is the Menu Button)		
A	Buttons																															
A1	Emergency Button																															
A2	Channel Selector																															
A3	Knob Volume Control and Power Switch Knob																															
A4	Digital Voice Record (DVR) Button																															
A5	PTT Button																															
A6	Function Status Button																															
A7	Keypad Lock Button																															
A8	Left Soft Button																															
A9	Right Soft Button																															
A10	Back Button																															
A11	Enter Button																															
A12	4-Way Navigation Button																															
A13	Home Button																															
A14	12-Keypad (1 key is the Menu Button)																															
<table border="1"> <thead> <tr> <th data-bbox="107 892 165 922">B</th> <th data-bbox="169 892 389 922">LED</th> </tr> </thead> <tbody> <tr><td>B1</td><td>Signaling LED (Red, Green and Amber)</td></tr> <tr><td>B2</td><td>Power LED (Blue)</td></tr> </tbody> </table>	B	LED	B1	Signaling LED (Red, Green and Amber)	B2	Power LED (Blue)																										
B	LED																															
B1	Signaling LED (Red, Green and Amber)																															
B2	Power LED (Blue)																															
<table border="1"> <thead> <tr> <th data-bbox="107 1016 165 1046">C</th> <th data-bbox="169 1016 389 1046">LCD</th> </tr> </thead> <tbody> <tr><td>C1</td><td>2"High Brightness Color Display (220 × 176)</td></tr> </tbody> </table>	C	LCD	C1	2"High Brightness Color Display (220 × 176)																												
C	LCD																															
C1	2"High Brightness Color Display (220 × 176)																															
<table border="1"> <thead> <tr> <th data-bbox="107 1115 165 1145">D</th> <th data-bbox="169 1115 389 1145">Accessory Port</th> </tr> </thead> <tbody> <tr><td>D1</td><td>Proprietary Dual Band GPS & VHF or UHF or 700/800 Antenna</td></tr> <tr><td>D2</td><td>Accessory Connector</td></tr> </tbody> </table>	D	Accessory Port	D1	Proprietary Dual Band GPS & VHF or UHF or 700/800 Antenna	D2	Accessory Connector																										
D	Accessory Port																															
D1	Proprietary Dual Band GPS & VHF or UHF or 700/800 Antenna																															
D2	Accessory Connector																															
<table border="1"> <thead> <tr> <th data-bbox="107 1256 165 1286">E</th> <th data-bbox="169 1256 389 1286">Microphone</th> </tr> </thead> <tbody> <tr><td>E1</td><td>Ambient Light Sensor for Automatic Keypad and LCD Brightness Control</td></tr> <tr><td>E2</td><td>Microphone</td></tr> </tbody> </table>	E	Microphone	E1	Ambient Light Sensor for Automatic Keypad and LCD Brightness Control	E2	Microphone																										
E	Microphone																															
E1	Ambient Light Sensor for Automatic Keypad and LCD Brightness Control																															
E2	Microphone																															
Left Side	Right Side																															

Part: BU3 OVERVIEW

2. TURNING THE UNICATION's RADIO ON AND OFF

2.1 Switch On

1. Rotate the Volume Control and Power Switch Knob clockwise until a click sound is heard.
2. Once the power is on, a self-test program automatically starts. If the test is successful, the display shows a greeting message on the display.
3. After briefly displaying the greeting message, the radio automatically enters into the standby mode.

2.2 Switch Off

1. To switch off the radio, simply rotate the Volume Control and Power Switch Knob counterclockwise until a click sound is heard.
2. The LEDs and display are turned off as a result.

3. ADJUSTING THE SPEAKER VOLUME

3.1 Adjust Volume

1. Slowly rotate the Volume Control and Power Switch Knob clockwise to increase the volume.
2. Rotate counterclockwise to lower the volume.

Note

Turning the knob counterclockwise until a click is heard turns off the radio.

4. SELECTING CHANNELS

In 2-way radio operation, users must select a channel for transmitting or receiving voice or data messages. The UNICATION's U3 radio can configure 1024 channels. These channels can be programmed to a user member or a group using UNICATION's U3 Programming Software, PPS.

4.1 Using The Channel Selector Knob

1. Rotate the Channel Selector Knob clockwise to next channel.
2. Rotate the Channel Selector Knob counterclockwise to previous channel.
3. When a different channel is selected, the channel information is shown on the display.

Switch On



Switch Off

Increase Volume



Decrease Volume

Switch to next Channel



Switch to previous Channel

Part: BU3 OVERVIEW

5. STANDBY AND MAIN MENU FUNCTION

5.1 Standby Mode

Users can use:

- 3. Left Soft Button: To enter the Today menu
- 4. Menu Button: Press 1 to enter the Main Menu
 - Right Soft Button: To enter the Contacts menu
 - PTT Button: To use the current channel to make a call



5.2 Channel Mode

UNICATION's radio simultaneously supports analog and digital modes. Users can choose one of the nine protocol modes.

No.	Model	Protocol Supported
1	DVOA	1. Analog Modes: <ul style="list-style-type: none"> a. Conventional carrier Squelch (CSQ) b. CTCSS/CDCSS d. 2Tone e. MDC1200, f. 5/6Tone, g. DTMF Encoder h. Digital Voice & Data over Analog (DVOA)
2	MPT1327	1. Analog Modes 2. MPT1327
3	P25C	APCO P25 Phase 1, Conventional
4	P25T	APCO P25 Trunking and Conventional
5	P25 + DVOA	1. APCO P25 Phase 1, Conventional 2. Protocol DVOA Supported
6	DMR	DMR
7	DMR + DVOA	1. DMR 2. Protocol DVOA Supported
8	UniDMR	UniDMR *R&R function can only be used under UniDMR Protocol.
9	DMR + DVOA	1. UniDMR *R&R function can only be used under UniDMR Protocol. 2. Protocol DVOA Supported

Encryption Models are Available

Part: BU3 OVERVIEW

5.3 Identifying Icon Indicators

The status bar on the top of the display indicates the radio status.



ICON	Description
	Signal strength
	Incoming message
00:44	Current time
	Acquiring GPS signals (Blinking)
	Received GPS signals
	Keypad locked
	Bluetooth activated
	Low TX power
	High TX power
	Digital mode
	Analog mode
	Analog mode (Digital Encryption)
	An emergency alarm is received.
	Full Battery
	50% Battery
	No power
	Alarm Clock activated
	Talk Around activated
	Auto Reply activated
	Man Down function activated
	The Speaker Microphone connected

Part: BU3 OVERVIEW

5.4 LED Indicators

LED	Behavior	Definition
Signaling LED	Flashing Green	Radio Transmitting
	Solid Red	Radio Receiving
Power LED	No Brightness	Power Off Charge Complete Radio Booting Complete
	Solid Blue	Radio Booting
	Flashing Blue	Bluetooth Connection

5.5 Main Menu

Press the Menu Button in standby mode, the radio enters the Main Menu, which is the entrance to all the radio's functions. Main menu has functions below :

No.	Function	No.	Function	No.	Function
1	Function Status	8	Call Log	15	Call Recording
2	Call Alert	9	Emergency Log	16	Zone
3	Today	10	Voice Memo	17	Scan
4	Message	11	Remote Monitor	18	Missing Car Search
5	Contacts	12	Radio Check	19	Missing People Search
6	Image Box	13	Tools		
7	Auto Reply	14	Settings	20	Suspect Search

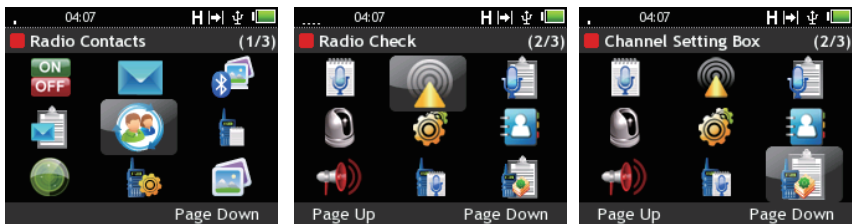

Part: BU3 OVERVIEW

5.6 Buttons

Users can use the buttons below to navigate the menu and other functions.

Button	Description
Left & Right Soft Buttons	Execute specific functions on the display.
4-Way Navigation Button	Select or scroll through the radio's items on the display.
Enter Button	Confirm a selection.
Back Button	Return to previous page.
Home Button	Return to the standby mode.
Digital Voice Record (DVR) Button	Record voice communications.
Push-to-Talk (PTT) Button	Transmit to other radios. When users want to speak, press and hold the PTT button to activate the microphone and transmit the voice. Release to listen.
Function Status Button	Enter the Function Status menu that displays the configurations of some common functions.
Keypad Lock Button	Long press to lock or unlock the keypad.
Emergency Button	Initiate an Emergency Alarm request.
Menu Button	Enter the Main Menu at standby mode by pressing the number 1 key.

Part C: U3 RADIO INSTALLATION SETTING

1. OPTIONAL ACCESSORIES

UNIFICATION radio provides many optional accessories for different applications; please contact your local dealer for more information.

1.1 STANDARD PACKAGE CONTENTS

1. U3 Portable radio
2. Battery Pack
3. Standard Charger
4. Charger Adaptor
5. Accessory Port Protective Cover

PartC : U3 RADIO INSTALLATION SETTING

2. HARDWARE INSTALLATION

2.1 CHARGING THE BATTERY

 **Warning:**

1. Do not charge the battery pack in a hazardous environment: it may cause an explosion.
2. To avoid damaging the radio, NEVER release or attach the battery pack if the radio is wet or covered with dust.
3. Do not charge the radio or the battery if it is wet.
4. Do not expose the charger to any liquid, rain, or snow.

2.1.1 Before using the Battery Pack for the first time

1. Please charge the battery with the Standard Charger for a minimum 5 hours. This ensures the maximum performance.
2. The U3 handheld two-way radio standard package contains a Standard Charger with an adapter. The Standard Charger has two slots, "Front Slot - battery pack with radio or battery pack only" and "Back Slot- battery pack only".
3. Before attaching the battery, make sure the U3 radio is turned off.

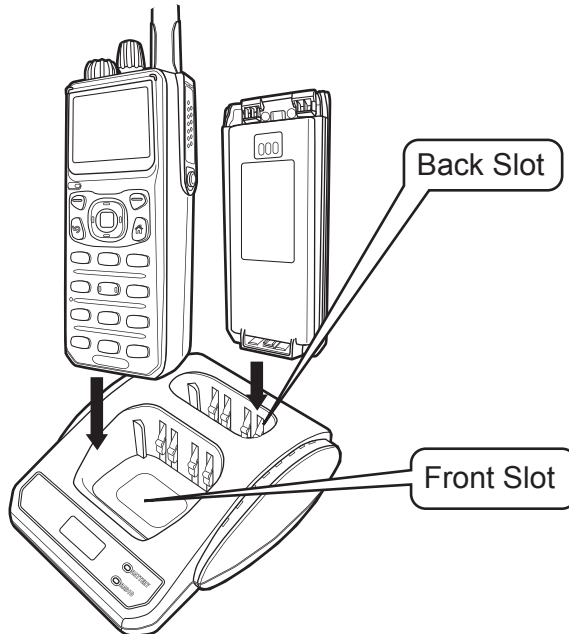

Part C: U3 RADIO INSTALLATION SETTING

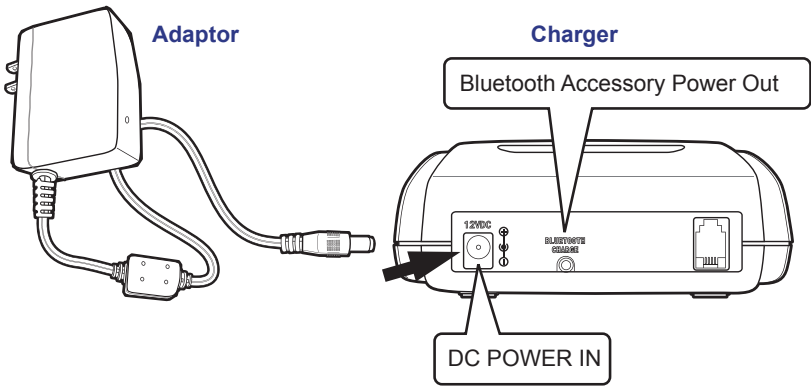

2.1.2 LED Indication of the Standard Charger

- Steady Orange ● : Battery Charging
- Flashing Green ☀ : Charged (90% Capacity)
- Steady Green ● : Charged (Full Capacity)
- Flashing Red ☀ : Battery Fault. Replace a new battery pack
- Alternate Green/Red ☀ : The battery capacity is getting low and it is near its end of life

2.2 INSTALLING THE ANTENNA

2.2.1 Attaching The Antenna

1. Ensure the radio is turned off when attaching the antenna.
2. As shown in the picture, hold the base of the antenna and screw the antenna clockwise into the connector.
3. Keep turning the antenna clockwise until secured.

Note

Never try to transmit without the antenna. This may damage the radio.

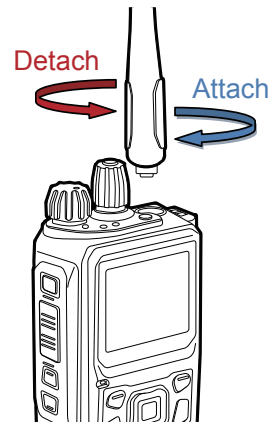

2.2.2 Detaching The Antenna

1. Make sure the radio is turned off when detaching the antenna.
2. As shown in the picture, twist the antenna counterclockwise to remove it from the radio.

Part C: U3 RADIO INSTALLATION SETTING

2.3 INSTALLING THE BATTERY PACK

2.3.1 Attaching The Battery Pack

1. Ensure the radio is turned off.
2. Insert the top of the battery pack into the radio.
3. Then push the bottom of the battery pack towards the radio and press down until hearing a click sound.

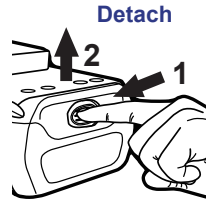

2.3.2 Removing The Battery Pack

1. To remove the battery pack, turn the radio off.
2. Press the release button on the bottom of the radio.
3. Once the battery pack is released, users can pull away the battery pack from the radio.

Part D: FUNCTIONS OPERATIONS

1. Function Status Menu

Users can check Function Status on the menu.

1.1 Enter Function Status Menu

There are two ways to enter the Function Status menu.

1.1.1 Press Function Status Button Function Status Button

Press the Left Soft Button in the standby mode to enter the Function Status menu.



1.1.2 Enter Function Status menu from the Main Menu

- a. In standby mode, press the Menu Button to enter the Main Menu.
- b. Use the 4-Way Navigation Button ◀▲▼▶ to navigate “Function Status” icon.
- c. Press the Enter Button to enter the Function Status menu.

1.2 TO SWITCH FUNCTION STATUS ON/OFF

In Function Status menu, users can switch the listed functions below :

No.	Function	No.	Function	No.	Function
1	Select Zone	5	Background noise suppression	9	GPS Engine
2	High Power	6	Channel Lock	10	GPS Display
3	Override	7	Mandown Alert	11	GPS Inform
4	Encryption	8	Monitor Mode	12	Bluetooth Setting

1.2.1 How to switch between on/off status

- a. When users enter the Function Status menu, the highlight bar stays at “Select Zone”.
- b. Press the Left Soft Button “Change” to switch the status between on and off. The related icon on status bar is updated at the same time.
- c. Use the 4-Way Navigation Button ▲▼ to move to next item.
- d. Users can press the Back Button to return to previous menu.

1.2.2 Details for certain features in Function Status menu

If the details features are available when selecting a certain feature, users can press the Navigation Button ◀▶ then press the Right Soft Button to “Setting”.

Part D: FUNCTIONS OPERATIONS

1.3 FUNCTIONS LISTED IN FUNCTION STATUS MENU

1.3.1 Zone

Select the Zone. A Zone can contain up to 16 Channels and must be set on the PPS. Channel capacity is 1024. (64 Zones).

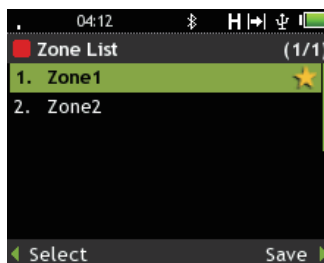

1.3.2 High Power

The radio has two levels of TX power. When turning on the High TX Power function, the unit's TX Power increases to 5W/4W/3W (VHF/UHF/700/800). When turning off the option, the TX Power reduces to 1W.

1.3.3 Override

This function provides users to force the radio to transmit when pressing and holding the PTT Button.



1.3.4 Encryption

Turn on the Encryption function to secure your message. The Encryption must be used in secure channel and be programmed by the Encryption software.

1.3.5 Background Noise Supression

Turn on to decrease background noise.

1.3.6 Channel Lock

Turn on to lock the channel knob.

1.3.7 Mandown Alert

Mandown Alert is activated when the radio falls from vertical to horizontal or is immobile after a preset time, and an emergency alarm is sent to designated radios or console with GPS coordinates.



1.3.8 Monitor Mode

In Analog, Monitor Mode is achieved by disabling Squelch. In Digital, Monitor Mode is achieved by not distinguishing incoming ID. Monitor Mode allows users to monitor signals of a certain frequency. If a message is received in this frequency, the U3 will automatically turn on the speaker and the message will be played.

Part D: FUNCTIONS OPERATIONS

1.3.9 GPS Engine

Turn on the GPS Engine to receive the GPS signals.

1.3.10 GPS Display

Turn on the GPS Display to show the location map. Users have to turn on the GPS Engine first. Users has to download a map with Unication Map Maker software.

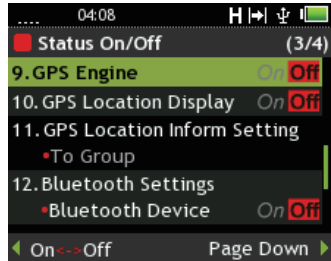

1.3.11 GPS Inform Setting

The radio can transmit GPS signal to other devices. Refer to Section 8 GPS Function for more details.

1.3.12 Bluetooth

The setting is to link with other Bluetooth devices. Refer to Section 1.4 BLUETOOTH SETTING for more details.

1.4 Bluetooth Setting

Users can use Bluetooth function to link accessories including Bluetooth earphone. The user needs to pair the Bluetooth accessories with the radio before using.

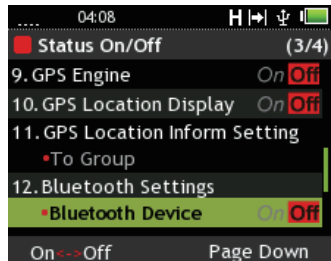

1.4.1 Turning on Bluetooth function

1. Use the 4-way Navigation button ▲▼ to select “BT Device” in the Function Status menu.
2. Press the Left Soft Button “Change” to enable Bluetooth function.
3. Press the Enter Button on “connect earphone” to start searching the bluetooth earphone.
4. Press the Enter Button on “Connect to other BT” to enter the setting to pairing with other device.

Part D: FUNCTIONS OPERATIONS

1.4.2 Pairing on Bluetooth device

1. Use 4-Way Navigation Button ▲▼ to select device and press the Right Soft Button to connect.
2. Users need to wait until when the radio is connected, once connected; the radio shows a successful prompt. If the radio fails to connect to other devices, try again or select another available device.

1.4.3 Turning off Bluetooth function

1. Use the 4-way Navigation button ▲▼ to select "Bluetooth" in the Function Status menu.
2. Press the Left Soft Button "Change" to enter to next menu.

1.4.4 Receiving an Image from Cell Phone

For first time connection, users have to add the radio to mobile phone's Bluetooth contact list.

> Pairing Radio and Phone

1. Turn on the Bluetooth function of the U3 and cell phone. Use Bluetooth function to search and pair cell phone.
2. Follow the instruction on the display, simply enter a pair code, try 0000 or 1234 and enter it on both the radio and phone.

> Sending Images or Photos from a Phone

1. Use a phone to select a photo to share.
Note: Check the phone manual for sending photos or images via Bluetooth, and the radio only accept images with resolution 640×480.
2. Select "Send" then choose via Bluetooth. The cell phone searches for devices with Bluetooth enabled in range.
3. Choose the "Unication" device and select, the cell phone shows a message saying "connecting".

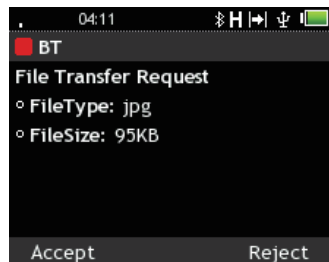
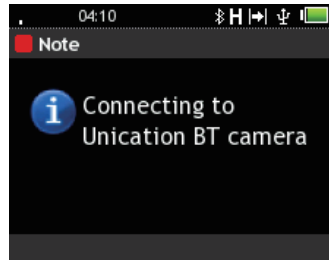
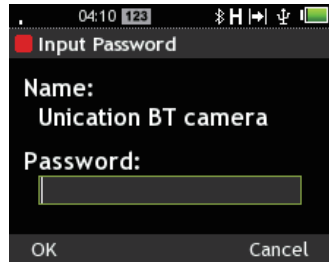
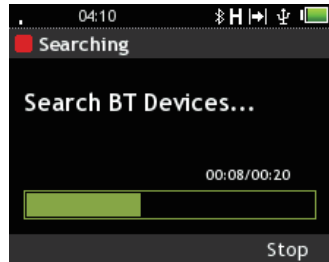

Part D: FUNCTIONS OPERATIONS

- The Radio asks if the user wants to accept the connection.
Press the Left Soft Button “Accept” to receive the Picture.
Press the Right Soft Button to cancel the connection.
- With acceptance, the radio shows a “Receive...” message and a status bar indicating the transmission progress.
- Check the radio to see whether the file is received. Users can check the received pictures in Image Box.

2. CHANNEL SETTING

U3 Portable radio can adjust channel frequency.

2.1 Channel Setting Function

2.1.1 Enter Channel Setting Function

- Enter Channel Setting Menu from Main Menu.
 - In standby mode, press the Menu Button to enter the Main Menu.
 - Use 4-Way Navigation Button ◀▶▶▶ to navigate to Frequency Setting Icon.
 - Press the Enter Key to enter next menu.

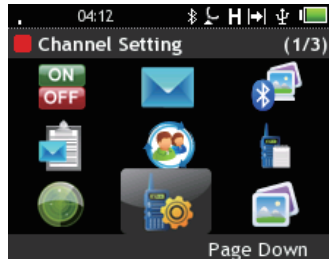

2.2 Frequency Setting

2.2.1 Select Channel

- Select “Frequency” and press the Enter Button to enter next menu in the Frequency Setting Menu.
- Use 4-Way Navigation Button ▲▼ to select “Current Channel” or “Other Channel” then press the Enter Button.
- If you selected “Other Channel”, the display shows Zone to select. A Zone can contain up to 16 Channels and must be setting in the PPS.

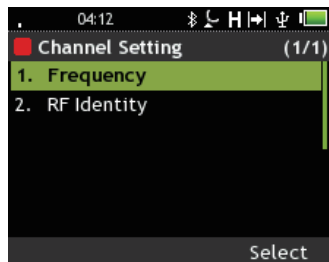

2.2.2 Set Frequency

- Use 4-Way Navigation Button ▲▼ to select “Tx Frequency”, “Rx Frequency”, “Tx Channel Spacing” or “Rx Channel Spacing”, press the Left Software Button to set.
- Please input the frequency by the Keypad.
Note: The frequency must be inputted with complete digits.
- Switch Channel Spacing setting by pressing the Left Software Button.
- Press the Right Software Button to save setting.



Part D: FUNCTIONS OPERATIONS

2.3 Set RF Identity

2.3.1 Select Channel

1. Select "RF Identity" in the Channel Setting menu. Press the Enter Button to enter next menu.
2. Use 4-Way Navigation Button ▲▼ to select "CTCSS", "CDCSS", "150Hz", "DMR Color Code" or "P25 NAC", and then press Enter Button.
3. Use 4-Way Navigation Button ▲▼ to select "Current Channel" or "Other Channel" then press the Enter Button.
4. If you selected "Other Channel", the display shows Zone to select. A Zone can contain up to 16 Channels and must be setting in the PPS.

2.3.2 Set RF Identity

1. Use Keypad to input the number.
2. Please use the Right Software Button to switch the 150Hz setting.
3. Press "Save" to save the setting.

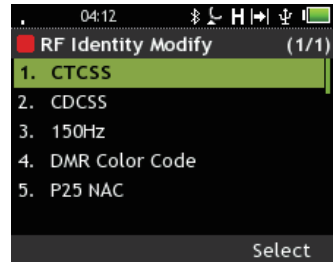

Part D: FUNCTIONS OPERATIONS

3. VOICE CALLS

Use this function to communicate with other radios or Console by transmitting or receiving voice calls. The display shows the contact information when communicating. The contact list is made and programmed to radios by using the PPS software.

3.1 **MAKING CALLS**

3.1.1 **To Make a Call**

1. The radio can be programmed to enable All Call, Group Call, and Private Call.
 - a. All Call: Talk with everybody in the same channel.
 - b. Group Call: Talk with a group in the same channel.
 - c. Private Call: Talk to an individual device.
2. Make a Call Directly
Press and hold PTT button in standby mode.
U3 will then transmit an All Call or a Group Call according to the channel settings.
3. Make an All Call
 - a. Select "All" on the Contacts menu.
 - b. Press and hold the PTT Button to transmit a call.
 - c. Release PTT Button to stop transmitting.
4. Make a Group Call or Private Call
 - a. Select "Group" or a contact name from the Contacts menu. For detailed information, please refer to section 3.1.2 Selecting a Contact.
 - b. Press and hold the PTT Button to transmit a call.



Note

- U3 displays "Channel Busy" when the channel is under using.
- To transmit encrypted calls, please set secure channel by PPS software and set Encryption key by Encryption Utility software. All radios communicating in the secure channel must be set with same Encryption key.

Part D: FUNCTIONS OPERATIONS

3.1.2 Selecting a Contact

Users can select a group or person by the following:

1. In the standby mode
 - a. Users can press the Right Soft Button in the standby to enter the Contacts menu.
 - b. Use the 4-Way Navigation Button ▲▼ to select a contact (if so pre-programmed).
2. From the Main Menu Function
 - a. Press the Menu Button in the standby mode to enter the Main Menu.
 - b. Press the Enter Button on “Contacts” icon.

Use the 4-Way Navigation Button ▲▼ to select a contact.

Refer to Section 13. CONTACTS.

3.2 RECEIVING CALLS

3.2.1 To Receive an All Call

While receiving an All Call, every radio on the current channel is announced.

The radio displays the channel alias with a Solid Red LED indication.

3.2.2 Receiving a Group Call Or Private Call

1. When receiving a Group Call or Private Call, the radio displays the caller’s alias and a Solid Red LED indication.
2. After the call, the radio automatically starts a hang time timer.
3. During the hang time, users can press the PTT Button to respond.

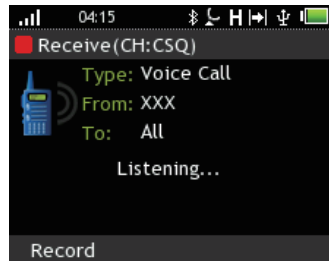

Note

U3 displays “Channel Busy” when the channel is under using.
To receive encrypted calls, please set secure channel by PPS software and set Encryption key by Encryption Utility software. All radios communicating in the secure channel must be set with same Encryption key.

Part D: FUNCTIONS OPERATIONS

3.3 CALL RECORDING

U3 supports to records voice calls.

3.3.1 Start Recording

1. During any call, press the DVR Button to start recording.
2. When it starts recording, an microphone icon is shown on the display.
3. During recording, press the DVR Button again or press the Left Soft Button “Finish” to stop recording.
4. Once the recoding stops, the radio returns to its previous page.



3.3.2 Managing Recording

1. Press the Menu Button to enter the Main Menu, then select the “Call Recording”.
2. Select the options by using 4-Way Navigation Button ▲▼ to select options.
3. Select “Received Recoding” to enter the page and use the 4-Way Navigation Button to ▲▼ to move the highlight bar to a recording. Press the Enter Button to listen to the recording.
4. To stop listening, press the Left Soft Button “Stop” to stop playing.
5. Use the 4-Way Navigation Button to switch the Left & Right Soft Button functions.
 - a. Lock: To lock the recording.
 - b. Delete: To delete the recording.
 - c. Delete All: To delete all recordings in the device.

3.4 Call Other Channel

Users can use Call Other Channel Function to call other channel without turning the knob.

3.4.1 Enter Call Other Channel Function

Users can use Call Other Channel Function to call other channel without turning the knob.

1. In standby mode, press the Menu Button to enter the Main Menu.
2. Use 4-Way Navigation Button ◀▲▼▶ to Call Other CH icon.
3. Press the Enter Button to next menu.

Part D: FUNCTIONS OPERATIONS

3.4.2 Use Call Other Channel Function

1. Use 4-Way Navigation Button ▲▼ to select the Zone contains the Channel you want to call, then press the Enter Button to continue.
2. Use 4-Way Navigation Button ▲▼ to select channel, then press the Enter Button to continue.
3. Use 4-Way Navigation Button ▲▼ to select a contact, press PTT Button to make a voice call.

Part D: FUNCTIONS OPERATIONS

4. EMERGENCY CALL

This radio provides an Emergency Call function. Once activated, the radio sends an emergency command on a pre-set channel.

4.1 **SENDING AN EMERGENCY CALL**

Activate the Emergency Call function is by pressing the Emergency Button. When the Emergency Call is received, the display shows the information of the receiver. Press and hold PTT button to transmit voice call in the Emergency channel.

Emergency Button



4.2 **DISABLE THE EMERGENCY CALL**

Deactivate the alarm by pressing the Emergency Button for 3 seconds.

4.3 **RECEIVING AN EMERGENCY CALL**

Radios can be set to receive Emergency Calls. If the radio is set to receive GPS data, it also shows the GPS location information.

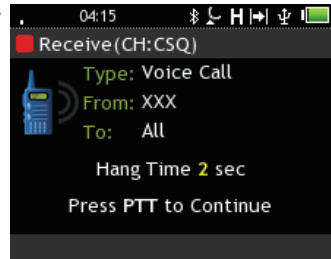

4.3.1 **To Receive Emergency Call Function**

1. If the radio receives an Emergency Call, it automatically alerts.
2. Press Left Soft Button "Location Tag" to show the location information of the received Emergency call.
3. Press the Right Soft Button "Monitor" to hear the sounds from the opposite radio. These sounds are received via the transmitted emergency call.
4. Press the Back Button to back to previous menu.

Part D: FUNCTIONS OPERATIONS

5. CALL ALERT

If there was no response to voice call, users can leave a "Call Alert" notice for the receiver. This reminds the receiver to call back.

5.1 SENDING A CALL ALERT

5.1.1 To Set a Call Alert

There are two ways to initiate a call alert.

1. Enter the Call Alert menu from the Main Menu
 - d. In standby mode, press the Menu Button to enter to the Main Menu.
 - e. Use the 4-Way Navigation Button ◀▶▶▶ to navigate to the "Call Alert" icon.
 - f. Press the Enter Button to enter the Call Alert menu.
2. Press the Right Soft Button to select the "Call alert" from the Contacts.

5.1.2 Select a Contact to Send a Call Alert

1. From the Call Alert menu, the highlight bar stays at "Send Call Alert". Press the Enter Button to enter to next menu.
2. Use the 4-Way Navigation button ▲▼ to move to the contact person to send the call alert.
3. Press the Left Soft Button "Send" to send a Call Alert.
4. The radio displays a message stating the transmission result.

5.2 RECEIVING A CALL ALERT

5.2.1 Receiving a Call Alert

1. When receiving a Call Alert, the radio alerts, users may use the following options to respond:
 - a. Press and hold the PTT Button to respond to the Call Alert sender.
 - b. Press the Back Button to end the alert prompt page.

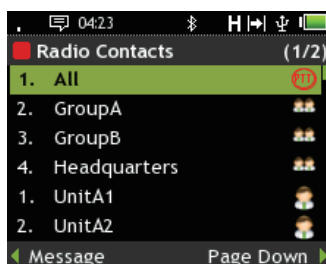
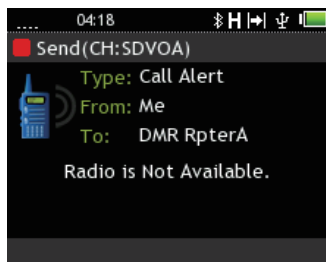
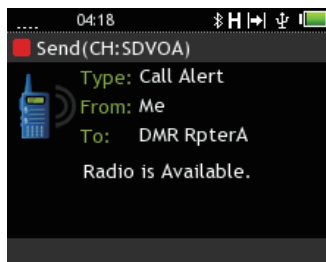
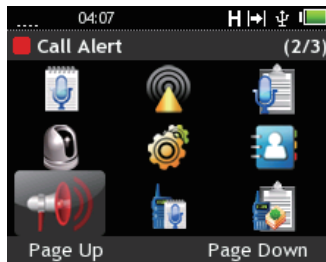

PTT Button



Part D: FUNCTIONS OPERATIONS

6. CALL LOG AND EMERGENCY LOG

The radio provides logs of previously received calls and Alarms with contact information. These log lists can be used as a shortcut to access relative functions.

6.1 VIEWING A CALL LOG

6.1.1 Enter Call Log by Main Menu

1. In standby mode, press the Menu Button to enter the Main Menu.
2. Use the 4-Way Navigation Button ◀▲▼▶ to navigate to the “Call log” icon.
3. Press the Enter Button to confirm selection and enter next menu.

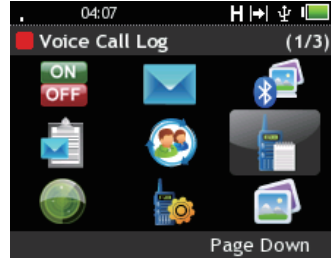

6.1.2 Call Log Operating

The “Sent Call log” is highlighted and shows latest sent logs. Users can press:

1. Use the 4-Way Navigation Button ▲▼ to move logs to view. Press and hold PTT button to make a voice call to the selected log contact.
2. Received log: Press the Left Soft Button “Received Log” to switch to display Received Call log. Press again to switch back.
3. Delete: Delete selected log.
4. Delete all: Delete all logs.

6.2 VIEWING AN EMERGENCY LOG

6.2.1 Enter Emergency Log by Main Menu

1. Press the Menu Button to enter Main Menu.
2. Use the 4-Way Navigation Buttonn ◀▲▼▶ to move to “Emergency log” icon.
3. Press the Enter Button to enter next menu.

6.2.2 Call Alert Log Operating

In the sent Call Alert Record, users can press the 4-Way Navigation Button▲▼ to move highlight bar to a contact ID and use the 4-Way Navigation Button ◀▶ and the Left & Right Soft Button to do the following actions:

1. Resend: Resend a call alert to this ID (only in the sent record).
2. Delete: Delete highlighted Call Alert Record.
3. Delete All: Delete all Records in this directory.

Part D: FUNCTIONS OPERATIONS

7. MESSAGES

In addition to voice communications, the radio also supports text messaging in digital mode. Users can transmit or receive canned or free composed message.

7.1 Enter the Message Function Menu

1. In standby mode, press the Menu Button to enter the Main Menu.
2. Use the 4-Way Navigation Button ◀▲▼▶ to navigate to the “Message” icon.
3. Press the Enter Button to confirm selection and enter next menu.

7.2 CANNED MESSAGE

Canned messages must be set in the PPS software and programmed to radio. Users can set 32 different canned messages.

7.2.1 Send A Canned Message

1. Use 4-Way Navigation Button to select “Send canned message” in the Message menu.
2. Press the Enter Button to enter next menu.
3. Use the 4-Way Navigation Button ▲▼ to move highlight bar to a canned Text to send.
4. Use the 4-Way Navigation Button ▲▼ to select the recipients.
5. Press the Left Soft Button “Send” to confirm transmission. This display shows the transmitting result.
6. Press Left software key to cancel transmission.

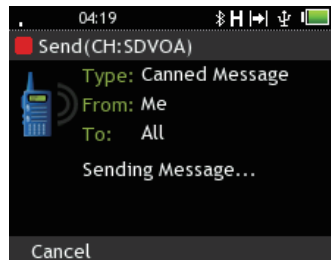
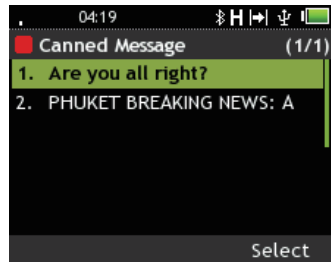
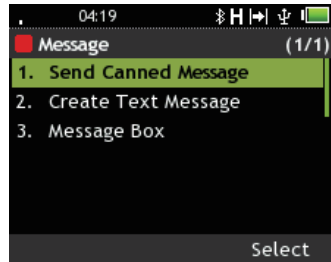
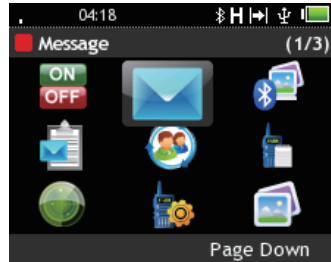

Part D: FUNCTIONS OPERATIONS

7.2.2 Choose a Text Entry Method

U3 supports multiple text entry methods for users to enter names, numbers, and messages. The method selected remains active until selecting another method. Press “#” key in any text entry display to switch the following entry methods, and the selected entry method is shown on the status bar:

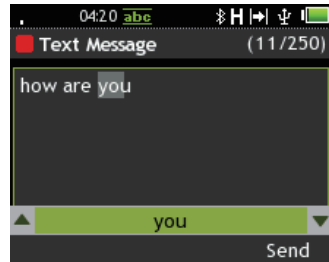

Users can select:

123 Numeric input mode: Only 0-9 numbers on the keypad can be entered into the text. Symbols are not applicable for Numeric input mode.

1/2 Press “1” key to show its symbols on the display. Use 4-Way navigation button to highlight the symbol, then press “Menu & Enter” key to select it.

abc
Abc Alphabet entry mode: press a keypad key repeatedly to cycle through the letters on the key. Repeat this step to enter each letter. There are three Alphabet modes that can be chosen in U3: all lower case, first alphabet cap, and all cap mode.

Abc
abc T9 smart text entry method: After alphabets are input in smart text entry method, the phrase associations are suggested, which eases the message entry compared to the single letter entry each time.

7.2.3 Attach an Image

1. Press the Right Soft Button “Attachment ” to attach a picture with the message.
2. Use the 4-Way Navigation Button ▲▼ to select the image to attach.
3. Press the Left Soft Button “Preview” to preview the selected image.
4. Press the Enter Button to confirm selection.

7.2.4 Send a Composed Message

1. Press the Left Soft Button “Send” after editing the message.c
2. Use the 4-Way Navigation Button ▲▼ to select the recipients.
3. Press the Left Soft Button “Send” to confirm transmission. This display shows the transmitting result.
Press Back button to cancel editing. Users can save the unfinished message as a draft.

Part D: FUNCTIONS OPERATIONS

7.3 READING MESSAGES

7.3.1 Read a Received Message

1. The radio automatically alerts the user when receiving a new message.
2. Press the Enter Button to read this message.
3. Press the “Home” button to return to the standby mode.

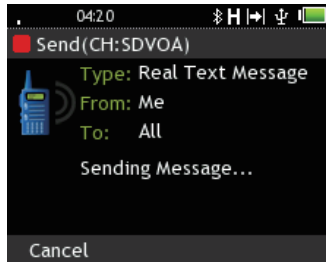

7.3.2 Read a Message in Inbox

1. Use the 4-Way Navigation Button ▲▼ to move highlight bar to the “Inbox” in the Message menu.
2. Press the Enter Button to confirm the selection.
3. Use the 4-Way Navigation Button ▲▼ to select a message.
4. Press the Enter Button to read the selected message.

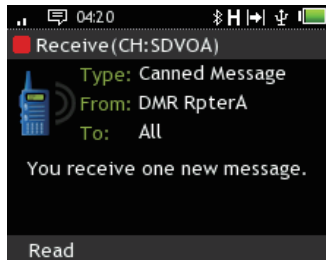

7.3.3 Manage Messages in Inbox

Users can select:

- a. Reply: Reply this message.
- b. Lock: Lock this message to avoid deleting.
- c. Delete: Delete the selected message.
- d. Delete All: Delete all messages.

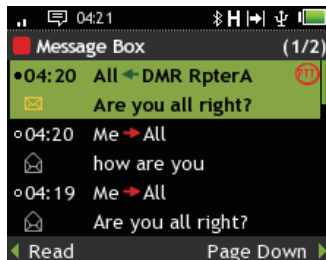

Part D: FUNCTIONS OPERATIONS

8. GPS FUNCTION

8.1 GPS Engine

To use the GPS functions, users have to switch on the GPS Engine first.

8.1.1 To Enable GPS Engine

Enable GPS function from the Function Status menu.

- Press the Function Status Button to enter the Function Status menu.
- Use the 4-Way Navigation Button ▲▼ to move the highlight bar to the “GPS Engine”.
- Press the Left Soft Button “Change” to enable this feature.
- Once GPS Engine is enabled, the  icon is shown on the status bar.

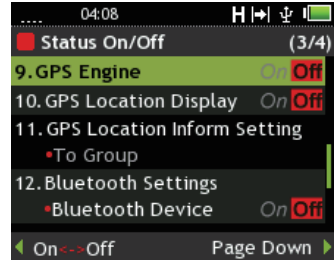

8.2 GPS INFORM

The “GPS Inform” function automatically sends GPS coordinates and other status information (such as Man down alarm) to the designated radio or console at a pre-determined time interval.

8.2.1 To Enable GPS Inform

Enable GPS inform function from the Function Status menu.

- Press the Function Status Button to enter the Function Status menu.
- Use the 4-Way Navigation Button ▲▼ to move the highlight bar to “To Group”, “To Console”, or “To Temp Console” under the “GPS Inform Setting”.
- If the current channel supports GPS inform, press the Left Soft Button “Change” to enable this feature, if there is no “Change” button, switch to a new channel, which supports GPS Inform feature.

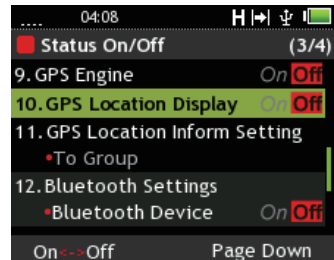

Part D: FUNCTIONS OPERATIONS

8.3 GPS DISPLAY

If GPS Engine is enabled, the radio is capable of providing a map with the relative positions of the team members. Download the map with Map Maker software first.

8.3.1 To Enter GPS Display Mode

1. Enter GPS Display Mode using the Function Status menu
 - a. Press the Function Status Button to enter the Function Status menu.
 - b. Use the 4-Way Navigation Button ▲▼ to move to the “GPS Display”.
 - c. Press the Enter Button to enter next menu.
 - d. If the radio contains map data, users can select to display now by the Enter Button or later by the Home Button.
 - e. Switch Map mode and standby mode by pressing the Home Button.

8.3.1 To Enter GPS Display Mode

1. Enter GPS Display Mode using the Function Status menu
 - a. Press the Function Status Button to enter the Function Status menu.
 - b. Use the 4-Way Navigation Button ▲▼ to move to the “GPS Display”.
 - c. Press the Enter Button to enter next menu.
 - d. If the radio contains map data, users can select to display now by the Enter Button or later by the Home Button.
 - e. Switch Map mode and standby mode by pressing the Home Button.

8.3.2 Use GPS Display Mode

Once in the GPS Display Mode, the radio searches for available satellite information. The search time depends on users' location. If the search time is longer than 4 minutes and 30 seconds, then it may not be possible to use GPS at the current location.

If GPS map is available, then the radio keeps detecting GPS data at a preset time interval with radio position at the center of the map.

Users can press the following optional functions:

- a. Press the Left Soft Button to change the scale of the map.
- b. Members: Use the 4-Way Navigation Button ▲▼ to move the highlight bar to a member. The position of the selected contact flashes.

8.3.3 Check One Member's Detailed Location

If pressing the Enter Button to select a team member, users can check the related detailed location.

Users can press:

- a. Details: To read the selected member's location information.
- b. Member: Click Members again to return to the GPS Display Mode.

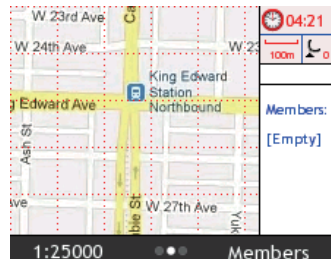

Part D: FUNCTIONS OPERATIONS

9. RADIO MONITOR

The master radio can monitor a remote radio and listen to the ambient audio in any channel. The Radio Monitor function is set by using the PPS software.

9.1 REMOTE MONITOR

If team member is in danger, users may want to know the surrounding environment of the member. Remote Monitor allows users to monitor another radio's received audio and listen to the ambient audio around the radio.

9.1.1 Use Remote Monitor Function

1. Enter Remote Monitor by Main Menu
 - a. In standby mode, press the Menu Button to enter Main Menu.
 - b. Use the 4-Way Navigation Button ◀▶▶▶ to navigate to "Remote Monitor" icon.
 - c. Press the Enter Button to enter the Remote Monitor menu.
 - d. Press the Left Soft Button "Monitor" to monitor to confirm selection.
 - f. Press the Enter Button to start monitoring.

Then U3 searches for selected radio signal, and the display shows the result after searching. Users can set the monitor duration by PPS software.
2. 2 Enter Remote Monitor from Contacts menu:
 - a. Press the Right Software Button to enter the Contacts menu.
 - b. Use the 4-Way Navigation Button ▲▼ to select a contact.
 - c. Use the 4-Way Navigation Button ◀▶ to switch software key function to Remote Monitor.
 - d. Press Right Software Button to start Remote Monitor.
 - e. The Radio will search for signal for a while, and then start to monitor if successfully receives signal. The monitor setting is set by the PPS.

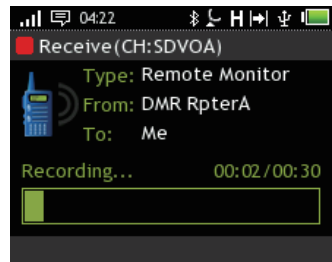
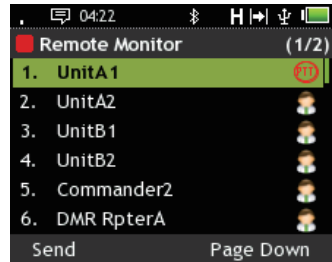

Part D: FUNCTIONS OPERATIONS

10. [RADIO CHECK](#)

10.1 RADIO CHECK

This feature allows users to determine if team members are in or out of signal range. Note that if there is no response, team member's radio could be turned off, broken, or out of range.

10.1.1 Enter Radio Check

1. Enter the Radio Check by Main Menu:
 - a. In standby mode, press the Menu Button to enter Main Menu.
 - b. Use the 4-Way Navigation Button ◀▲▼▶ to navigate to "Radio Check" icon.
 - c. Press the Enter Button to enter next menu.
 - d. Use the 4-Way Navigation Button ▲▼ to select "Send Radio Check" then press the Enter Button.
 - e. Use the 4-Way Navigation Button ▲▼ to select a contact.
 - f. Press the Left Soft Button "Radio Check" to start checking.
 - g. Press the Left Soft Button "Stop" to stop checking.
 - h. The display shows the checking result.
2. Use Radio Check by Contact:

Users can use Radio Check in the Contact menu. Please refer to section 13 CONTACT for further details.

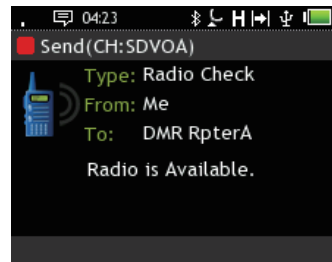

Part D: FUNCTIONS OPERATIONS

11. MONITOR MODE

In Analog, Monitor Mode is achieved by disabling Squelch.

In Digital, Monitor Mode is achieved by not distinguishing incoming ID.

Monitor Mode allows users to monitor signals of a certain frequency. If a message is received in this frequency, the U3 will automatically turn on the speaker and the message will be played.

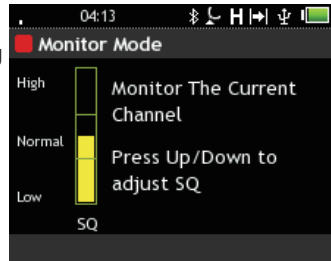

11.1 Enter Monitor Mode from the Function Status menu.

1. Press the Function Status Button to enter the Function Status menu.
2. Use the 4-Way Navigation Button ▲▼ to move the highlight bar to the "Monitor Mode".
3. Press the Right Soft Button "Change" to enable this feature.
4. Monitor current channel frequency without distinguishing incoming ID.

Part D: FUNCTIONS OPERATIONS

12 OVER THE AIR FUNCTION (OTA)

Users can use below function to control other radio remotely. This function can be used only by authorisation.

12.1 Channel Setting Box

12.1.1 Enter Channel Setting Box from the Main Menu:

1. In standby mode, press the Menu Button to enter the Main Menu.
2. Use the 4-Way Navigation Button ◀▲▼▶ to select "Channel Setting Box" icon.
3. Press the Enter Button to enter next menu.

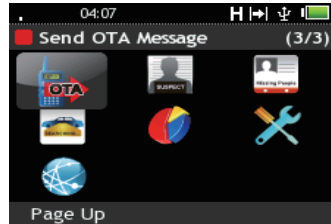

12.1.2 Channel Setting Operation

1. If users have used the Channel Setting function, the Channel Setting Box shows the records.
2. Use the Right Software Button "OTAP" to show detailed information.
3. Press the Right Software Button "Send" to confirm. After selecting a contact, press the Left Software Button "Send" to continue.
4. Input the password, and then press the Left Software Button "Send" to program other radio remotely.

12.2 Send Over The Air Control Message

12.2.1 Enter OTAC Function from the Main Menu:

1. In standby mode, press the Menu Button to enter the Main Menu.
2. Use the 4-Way Navigation Button ◀▲▼▶ to move to the "Send OTA Message" icon.
3. Press the Enter Button to enter next menu.

12.2.2 OTA Operation

1. Please select "Radio Disable" if you want to disable other radio.
2. Select the radio channel, select the radio then press the Left Button "Send".
3. Input the password, then press Send.
4. Select "Radio Enable" to enable the radio.

Part D: FUNCTIONS OPERATIONS

13. CONTACTS

Radio contact information is stored under Contacts. This information is created by using the Product Programming Software (PPS). Please note the Contacts cannot be edited from the radio.

13.1 VIEWING CONTACTS

There are two ways to access the Contacts.

13.1.1 Enter Contacts Function

1. Enter Contacts from menu
 - a. In standby mode, press the Menu Button to enter the Main Menu, use the 4-Way Navigation Button ◀▲▼▶ to navigate to the "Contacts" icon.
 - b. Press the Enter Button to enter the Contacts menu.
2. Press the Right Soft Button "Contacts" in standby mode.

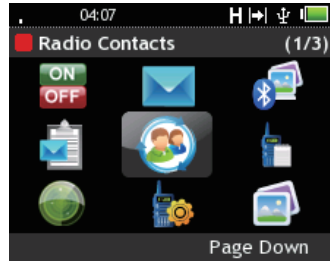

13.2 COMMUNICATE WITH CONTACTS

13.2.1 Communicate with an All or Group ID

1. In Contacts menu, use 4-Way Navigation button ▲▼ to move to a All or Group ID.
2. In this optional menu, users can do the following functions
 - a. Message: To send message to this Group ID.
 - b. Press and hold the PTT button to call this Group ID.

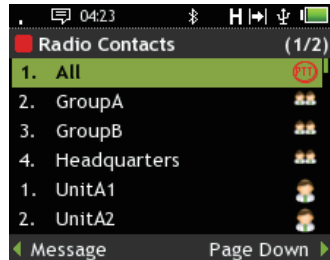

13.2.2 Communicate with a Private ID

1. For private ID, operations are similar to managing an All or Group ID, but users can use the 4-Way Navigation Button ◀▶ to select the option functions:
 - a. Message: To send message to this ID.
 - b. Call alert: To send a call alert to this ID.
 - c. Remote Monitor: To monitor this ID.
 - d. Radio check: To check this ID whether in the radio cover range.
 - e. Remote Monitor: Monitor other radio. Only authorized user can use this function.

Part D: FUNCTIONS OPERATIONS

14. IMAGE BOX

U3 can collect image messages and file them into the Image Box. Users can easily review images by using this function.

14.1 IMAGE BOX

14.1.1 ENTER THE IMAGE BOX

1. In standby mode, press the Menu Button to enter the Main Menu.
2. Use the 4-Way Navigation Button ◀▲▼▶ to navigate to the “Image Box” icon.
3. Press the Enter Button to enter next menu.

14.1.2 Select Image Search Type

1. Use the 4-Way Navigation Button ▲▼ to select a image search type.
There are 3 type to be selected: Slideshow, Date and Contact.
2. Press the Enter Button to enter next menu .
3. Operate the radio by the search type:
 - a. Slideshow: View the images by the 4-Way Navigation Button▲▼.
 - b. Date: Use the 4-Way Navigation Button ◀▲▼▶ and Keypad to input the date.
 - c. Contact: Use the 4-Way Navigation Button ▲▼ to select a source, press the Enter Button to enter next menu.
4. Use the 4-Way Navigation Button ▲▼ to select an image.
5. Users can select:
 - a. Display: Display the selected image.
 - b. Send: Send the selected image to a contact.
 - c. Lock: To lock the image. Locked image can not be deleted.
 - d. Delete: Delete the selected image.
 - e. Page up/Page down: Switch the image box page.

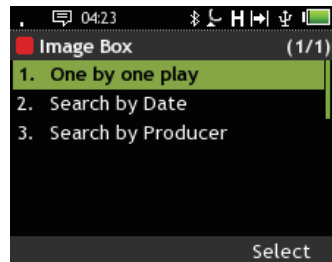

Part D: FUNCTIONS OPERATIONS

14.1.3 View Images

Users can select below function in the Image Box:

- a. Title: To Edit the image title.
- b. Send: To send the image.
- c. Text Note: To edit or read the text note of the image.
- d. Voice Note: To edit or listen to the voice record of the image.
- e. Location Tag: To edit or read the GPS information of the image.

Part D: FUNCTIONS OPERATIONS

15. DATABASE FUNCTIONS

Users can use the Database Functions to view the records created and managed by the Database Maker software. There are total three categories of records: Missing Car, Missing People and Suspect.

15.1 **Missing Car Search**

15.1.1 **Use the Missing Car Search Function**

1. In standby mode, press the Menu Button to enter the Main Menu. Use the 4-Way Navigation Button ◀▲▼▶ to navigate to the “Missing Car Search” icon.
2. Press the Enter Button to enter next menu.
3. Use the 4-Way Navigation Button ▲▼ to select “List all”, “Search by the license plate”, or “Search by the VIN”
4. Press the Enter Button to confirm.
 - a. List All.
 - b. Search by license plate: Enter the plate number with Keypad, then press the Left Software Button to search.
 - c. Search by the VIN: Enter the VIN with Keypad, then press the Left Software Button to search.
5. Users can press:
 - a. Details: To read the selected missing car record.
 - b. Unlock: To lock or unlock the selected missing car record.
 - c. Delete: To delete the selected missing car record.

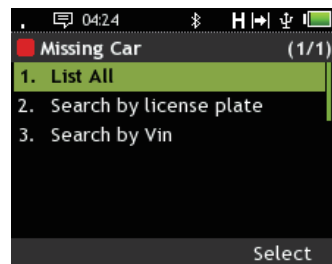
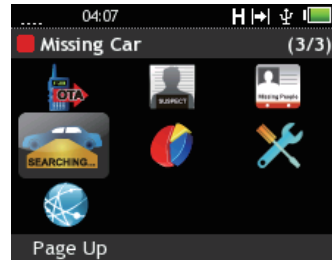

15.2 **Missing People Search**

15.2.1 **Use the Missing People Search Function**

1. In standby mode, press the Menu Button to enter the Main Menu. Use the 4-Way Navigation Button ◀▲▼▶ to navigate to the “Missing People Search” icon.
2. Press the Enter Button to enter next menu.
3. The highlight bar stays at a category of the missing people, use the 4-Way Navigation Button ▲▼ to choose a category and press the Enter Button to next menu. There are four categories, “Missing Male/Adult”, “Missing Female/Adult”, “Missing Boy”, and “Missing Girl”.

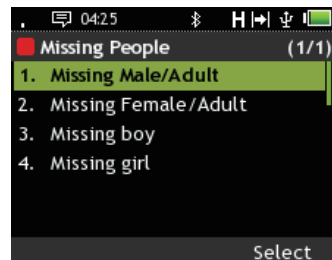

Part D: FUNCTIONS OPERATIONS

4. Use the 4-Way Navigation Button ▲▼ to switch the profile of the missing people.
5. Users can press:
 - a. Details: To read the missing people record.
 - b. Use as wallpaper: Show the pictures of the selected missing people on the display.
 - c. Delete: Delete the record of the selected missing people.
 - d. Unlock: To lock or unlock the record of the selected missing people.

15.3 Suspect Search

15.3.1 Use the Suspect Search Function

1. In standby mode, press the Menu Button to enter the Main Menu. Use the 4-Way Navigation Button ◀▶ to navigate to the “Missing Car Search” icon.
2. Press the Enter Button to enter next menu.
3. Use the 4-Way Navigation Button ▲▼ to select “List all”, “Search by the license plate”, or “Search by the VIN”
4. Press the Enter Button to confirm.
 - a. List All.
 - b. Search by license plate: Enter the plate number with Keypad, then press the Left Software Button to search.
 - c. Search by the VIN: Enter the VIN with Keypad, then press the Left Software Button to search.
5. Users can press:
 - a. Details: To read the selected missing car record.
 - b. Unlock: To lock or unlock the selected missing car record.
 - c. Delete: To delete the selected missing car record.
 - d. Unlock: To lock or unlock the record of the selected suspect.

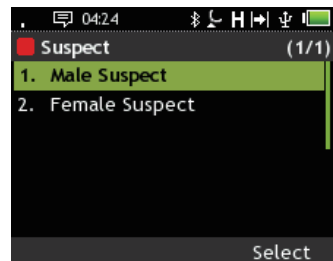
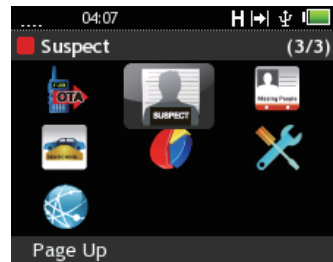

Part D: FUNCTIONS OPERATIONS

16. PERSONAL ASSISTANT

16.1 CALL AUTO REPLY

Once this function has been activated, the radio reminds the caller to leave a voice message when receiving private calls or call alerts.

16.1.1 Enable Call Auto Reply Function

Enable Auto Reply function from Function Status menu.

- a. At any time, user can press the Function Status Button to enter Function Status menu.
- b. Use the 4-Way Navigation Button ▲▼ to move highlight bar to the “Auto Reply”.
- c. Press the Left Soft Button “Switch On” to enable “Auto Reply” function.
- d. Once Auto Reply is enabled, then the  icon is shown on the status bar.

16.1.2 Enter Auto Reply Menu

1. Enter Auto Reply settings by Main menu
 - a. In standby mode, press the Menu Button to enter the Main Menu.
 - b. Navigation Button ◀▲▼▶ to navigate to the Auto Reply icon.
 - c. Press the Enter Button to enter the Auto Reply menu.

16.1.3 View Recorded messages

After activating the Auto Reply Function, U3 records voice messages in “Recorded messages” automatically.

1. Use the 4-Way Navigation Button ▲▼ to select Recorded messages in the Auto Reply menu.
2. Press the Enter Button to enter next menu.
3. Users can select :
 - a. Use the 4-Way Navigation Button ▲▼ to select a recorded message.
 - b. Lock: To lock the message. Locked message can not be deleted.
 - c. Delete: Delete the selected message.
 - d. Delete All: Delete all messages.

Part D: FUNCTIONS OPERATIONS

16.2 VOICE MEMO

This radio supports voice memo recording.

16.2.1 Enter Voice Memo Menu

1. In standby mode, press the Menu Button to enter the Main Menu.
2. Use the 4-Way Navigation Button ◀▲▼▶ to select “Voice Memo” icon.
3. Press the Enter Button to enter the next menu.

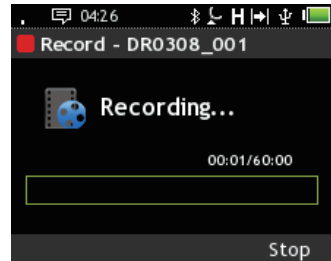

16.2.2 Record Voice Memo

1. After entering the Voice Memo menu, select “Add new” by pressing the Right Software Button to start recording.
2. The display shows the recording process.
3. Press the Left Software Button “Stop” to save the recording.

16.2.3 Play Voice Memo

1. Press the Menu Button to enter the Main Menu then select “Voice Memo”
2. Use the 4-Way Navigation Button ◀▶ to switch the toolbar to the following sub-functions:
3. Users can use:
 - a. Play: Play selected Voice Memo.
 - b. Stop: Stop playing.
 - c. Rename: To rename the voice memo
 - d. On/off Alarm: To set as Alarm.
 - e. Lock: To lock the recording.
 - f. Delete: To delete the voice memo.
 - g. Delete All: To delete all voice memos in the device.

16.2.4 Inform Setting

1. Press the Left Software Button “Set Alert” on the Voice Memo.
2. Use the 4-Way Navigation Button ◀▲▼▶ and keypad to set time and date of the alert, then press the Left Software Button “Save” to save setting.
3. Press the Right Software Button “Turn Off” to turn off the alert.

Part D: FUNCTIONS OPERATIONS

17. TOOLS

Users can use this function to set alarm and check the memory usage status.

17.1 TOOL MENU

17.1.1 Enter the Tool Menu

1. In the standby mode, press the Menu Button to enter the Main Menu.
2. Use the 4-Way Navigation Button ◀▲▼▶ to navigate to “Tools” icon.
3. Press the Enter Button to enter to next menu.

17.2 MEMORY

17.2.1 Check the Memory Usage

1. Use the 4-Way Navigation Button ▲▼ to select Memory in the Tool menu.
2. With this function, users can check the current radio memory usage status.

17.3 INFORMATION

17.3.1 Check Information

1. Use the 4-Way Navigation Button ▲▼ to select Information in the Main Menu.
2. Press enter button to check radio information.

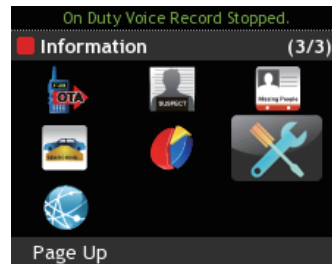

Part D: FUNCTIONS OPERATIONS

18. SYSTEM ALARM

When an abnormal status is detected, the Radio flashes a red LED and continuously alert with a low frequency tone.

18.1 RF Hardware Alarm Signals (MCU)

1. There are three RF Hardware alarms problems:
 - a. Lo Alarm: When DSP has LO problem.
 - b. MOD Alarm: When DSP has MOD problem.
 - c. PA Alarm: When PA temperature is high.

If the RF Hardware Alarm Signals occur, turn off the radio immediately and contact customer support.

18.2 Other Alarms

1. Temperature:
 - Alerts when the radio has temperature problem.
 - > Too hot
 - > Low temperature
2. Low Voltage:
 - When the battery voltage is too low to:
 - > Preventing a transmission
 - > Limits use of the radio

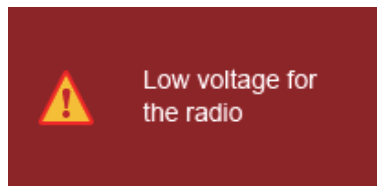
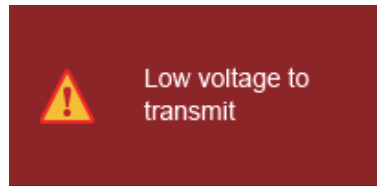
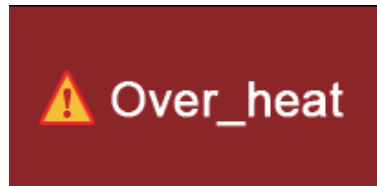
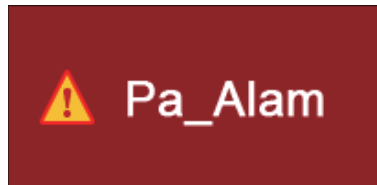

Part F: WARRANTY AND SAFETY INFORMATION

1. LIMITED WARRANTY AND SERVICE

Unication warrants the Unication manufactured Communication Products listed below ("Product") against defects in material and workmanship under normal use and service for a period from the date of purchase as scheduled below.

➤ U3 two way radio: Five (5) Year

2. FCC Part 15 Declaration of Conformity

This device complies with Part 15 of the FCC Rules. Operation is subject to the following two conditions:

1. This device may not cause harmful interference
2. This device must accept any interference received, including interference that may cause undesired operation.

Note

The changes or modifications not expressly approved by Manufacturer could void the user's authority to operate the equipment. The user should not modify or change this equipment without written approval from Manufacturer.

3. SAFETY INFORMATION



CAUTION:

BEFORE USING THIS RADIO, PLEASE READ THIS BOOKLET WHICH CONTAINS IMPORTANT OPERATING INSTRUCTIONS FOR SAFE USAGE, RF ENERGY AWARENESS, CONTROL INFORMATION AND OPERATIONAL INSTRUCTIONS FOR COMPLIANCE WITH RF ENERGY EXPOSURE LIMITS IN APPLICABLE NATIONAL AND INTERNATIONAL STANDARDS.

READ THE INSTRUCTIONS AND INFORMATION ON INTRINSIC SAFETY ON PAGE 11 OF THIS BOOKLET.

RF Energy Exposure Awareness and Control Information and Operational Instructions for Occupational Use

Note

This radio is intended for use in occupational or controlled conditions where users have full knowledge of their exposure and can exercise control over their exposure to meet the occupational limits in FCC and International standards. This radio device is NOT authorized for general population consumer use.

Part F: WARRANTY AND SAFETY INFORMATION

This two-way radio uses electromagnetic energy in the radio frequency (RF) spectrum to provide communications between two or more users over a distance.

It applies radio waves or radio frequency (RF) energy to transmit and receive voice calls or data. RF energy is one form of electromagnetic energy. Other forms include, but are not limited to, sunlight and x-rays. RF energy, however, should not be confused with these other forms of electromagnetic energy, which when used improperly, can cause biological damage. Very high levels of x-rays, for example, can damage tissues and genetic material.

Experts in science, engineering, medicine, health, and industry work with organizations to develop standards for safe exposure to RF energy. These standards provide recommended levels of RF exposure for both workers and the general public. These recommended RF exposure levels include substantial margins of protection.

All UNICATION U3 two-way radios are designed, manufactured, and tested to ensure they meet government-established RF exposure levels. Additionally, manufacturers also recommend specific operating instructions to users of two-way radios. These instructions are essential because they inform users about RF energy exposure and provide simple procedures on how to control it. Please refer to the following websites for more information on what RF energy exposure is and how to control your exposure to assure compliance with established RF exposure limits:

<http://www.fcc.gov/oet/rfsafety/rf-faqs.html>

<http://www.osha.gov/SLTC/radiofrequencyradiation/index.html>

Federal Communication Commission (FCC) Regulations

The FCC rules require manufacturers to comply with the FCC RF energy exposure limits for portable two-way radios before they can be marketed in the U.S. When two-way radios are used as a consequence of employment, the FCC requires users to be fully aware of and able to control their exposure to meet occupational requirements. Exposure awareness can be facilitated by the use of a product label directing users to specific user awareness information. Your UNICATION U3 two-way radio has a RF Exposure Product Label. In addition, your UNICATION U3 user manual and separate safety booklet includes information and operating instructions required to control your RF exposure and to satisfy compliance requirements.

Part F: WARRANTY AND SAFETY INFORMATION

Compliance with RF Exposure Standards

UNICATION's U3 two-way radio is designed and tested to comply with a number of national and International standards and guidelines (listed below) for human exposure to radio frequency electromagnetic energy. **This radio complies with the IEEE (FCC) and ICNIRP exposure limits for occupational/controlled RF exposure environments at operating duty factors of up to 50% talk-50%listen and is authorized by the FCC for occupational use only.** In terms of measuring RF energy for compliance with these exposure guidelines, **your radio generates measurable RF energy only. while it is transmitting (during talking), not when it is receiving (listening) or in standby mode.**

Note

The approved batteries, supplied with this radio, are rated for a 5-5-90 duty factor (5% talk-5% listen-90% standby) even though this radio complies with FCC occupational exposure limits and may operate at duty factors of up to 50% talk.

UNICATION P25 two-way radio complies with the following RF energy exposure standards and guidelines:

- United States Federal Communications Commission, Code of Federal Regulations; 47CFR part 2 sub-part J
- American National Standards Institute (ANSI) / Institute of Electrical and Electronic Engineers (IEEE) C95. 1-1992
- Institute of Electrical and Electronic Engineers (IEEE) C95.1-1999 Edition
- International Commission on Non-Ionizing Radiation Protection (ICNIRP) 1998
- Ministry of Health (Canada) Safety Code 6. Limits of Human Exposure to Radiofrequency Electromagnetic Fields in the Frequency Range from 3 kHz to 300 GHz, 1999
- Australian Communications Authority Radio communications (Electromagnetic Radiation – Human Exposure) Standard, 2003
- ANATEL ANNEX to Resolution No. 303 of July 2, 2002 "Regulation of limitation of exposure to electrical, magnetic and electromagnetic fields in the radiofrequency range between 9 KHz and 300 GHz" and "Attachment to resolution #303 from July 2, 2002"

RF Exposure Compliance and Control Guidelines and Operating Instructions

To control your exposure and ensure compliance with the occupational/controlled environment exposure limits, always adhere to the following procedures.

GUIDELINES :

- Do not remove the RF Exposure Label from the device.
- User awareness instructions should accompany device when transferred to other users.
- Do not use this device if the operational requirements described herein are not met.

Part F: WARRANTY AND SAFETY INFORMATION

Operating Instructions

- Transmit no more than the rated duty factor of 50% of the time. To transmit (talk), push the Push-To-Talk (PTT) button. To receive calls, release the PTT button. Transmitting 50% of the time, or less, is important because this radio generates measurable RF energy exposure only when transmitting (in terms of measuring for standards compliance).
- Hold the radio in a vertical position in front of the face with the microphone (and other parts of the radio including the antenna) at least one inch (2.5 centimeters) away from the nose or lips. Antenna should be kept away from the eye. Keeping the radio at a proper distance is important since RF exposures decrease with increasing distance from the antenna.
- When worn on the body, always place the radio in the UNICATION P25-approved belt clip for this product. Using approved body worn accessories is important because the use of non-UNICATION P25-approved accessories may cause exposure levels, which exceed the FCC occupational/controlled environment RF exposure limits.
- If you are not using a body-worn accessory and are not using the radio in the intended-use position in front of the face (one inch away), ensure the antenna and the radio are kept at least 0.75 inches (1.9 centimeters) from the body when transmitting. Keeping the radio at a proper distance is important because RF exposures decrease with increasing distance from the antenna.

Approved Accessories

- Use only UNICATION U3 -approved supplied or replacement antennas, batteries, and accessories. The use of Non-UNICATION P25 approved antennas, batteries, and accessories may exceed the FCC (IEEE) and ICNIRP RF exposure guidelines.
- Here is a list of UNICATION U3 -approved accessories: Belt Clip, External Speaker Mic. with wired earpiece, clone cable, USB cable, the 2400mAh Lithium Polymer battery, and the cradle charger.

Electromagnetic Interference/Compatibility

Note

Nearly every electronic device is susceptible to electromagnetic interference (EMI) if inadequately shielded, designed, or otherwise configured for electromagnetic compatibility.

Part F: WARRANTY AND SAFETY INFORMATION

Facilities

To avoid electromagnetic interference and/or compatibility conflicts, Switch OFF your radio in any facility where posted notices instruct you to do so. Hospitals or healthcare facilities may be using equipment that is sensitive to external RF energy.

Aircraft

When instructed to do so, switch off your radio when on board an aircraft. Any use of a radio must be in accordance with applicable regulations per airline crew instructions.

Medical Devices

Pacemakers

The Advanced Medical Technology Association recommends that a minimum separation of 6 inches (15 centimeters) be maintained between a handheld wireless radio and a pacemaker. These recommendations are consistent with those of the U.S. Food and Drug Administration.

Persons with pacemakers should:

ALWAYS keep the radio more than 6 inches (15 centimeters) from their pacemaker when the radio is turned ON.

Not carry the radio in the breast pocket.

- Use the ear opposite the pacemaker to minimize a potential interference.
- Turn the radio off immediately if there is any reason to suspect that interference is taking place.

Other Medical Devices

If any other personal medical devices are used, please consult the manufacturer of your device to determine if it is adequately shielded from the RF energy. Your physician may be able to assist you in obtaining this information.

Use of Communication Devices While Driving

Always check the law and regulations on the use of radios in the areas where you are driving.

Give full attention to driving and to the road.

Use hands-free operation, if available.

Pull off the road and park before making or answering a call, if driving conditions or regulations so require.

Part F: WARRANTY AND SAFETY INFORMATION

4. Operational Warnings



CAUTION:

For Vehicle with Air Bags:

Refer to vehicle manufacturer's manual prior to installation of electronic equipment to avoid interference with air bag wiring.

Do not place a portable radio in the area over an air bag or in the path of a deployment area. Air bags inflate with great force. If a portable radio is placed in the air bag deployment area and when the airbag inflates, the radio may be propelled with great force and cause serious injury to occupants of the vehicle.

Potentially Explosive Atmospheres

(Explosive atmospheres refer to hazard classified locations that may contain hazardous gas, vapors, or dusts.) Switch off your radio prior to entering any area with a potentially explosive atmosphere unless it is a portable radio type especially qualified for use in such areas as Intrinsically Safe (for example, Factory Mutual, CSA, UL, or CENELEC).

Do not remove, install, or charge batteries in such areas. Sparks in a potentially explosive atmosphere can cause an explosion or fire resulting in bodily injury or even death.

The areas with potentially explosive atmospheres referred to the above include fueling areas such as below decks on boats, fuel or chemical transfer or storage facilities, and areas where the air contains chemicals or particles such as grain, dust or metal powders. Areas with potentially explosive atmospheres are often, but not always, posted.

Blasting Caps and Blasting Areas

To avoid possible interference with blasting operations, turn off your radio when you are near electrical blasting caps, in a blasting area, or in areas posted: "Turn off two-way radio." Obey all signs and instructions.

Water Environment

If the radio has been submerged in water, dry and clean the radio and the accessories to avoid the interference of the water. Do not disassemble the radio. This could damage radio seals and result in leak paths into the radio.

Part F: WARRANTY AND SAFETY INFORMATION

5. Operational Cautions



CAUTION:

Antennas

- Do not use any portable radio that has a damaged antenna. If a damaged antenna comes into contact with your skin, it might cause a minor burn.
- Do not hold onto the antenna when the radio is powered on. Always keep the antenna at least 0.75 inches (1.9 cm) away from the body and 1 inch (2.54 cm) from the face when transmitting to ensure FCC RF exposure compliance requirements are not exceeded.

Batteries

All batteries can cause property damage and/or bodily injury, such as burns, if a conductive material such as jewelry, keys, or beaded chains touches exposed terminals. The conductive material may complete an electrical circuit (short circuit) and become quite hot. Exercise care in handling any charged battery, particularly when placing it inside a pocket, purse, or other container with metal objects.

Intrinsically Safe Radio Information

The Intrinsically safe approval unit refers to a product that has been approved as intrinsically safe by an approval agency (for example FM Approvals, CSA, UL, or Cenelec) and certifies that a particular product meets the Agency's applicable intrinsic safety standards for specific types of hazardous classified locations. A portable radio that has been approved for intrinsic safety will have an approval label attached to the radio to identify the unit as being approved for specified hazardous atmospheres. This label specifies the hazardous Class/Division/Group along with the part number of the battery that must be used. The Intrinsically Safe Approval Label will be located on the portable radio unit.

Part F: WARRANTY AND SAFETY INFORMATION

6. Operational Cautions for Intrinsic Safe Equipment



CAUTION:

- Do not operate radio communications equipment in a hazardous atmosphere unless it is a type especially qualified (for example, FM,UL, CSA, or GENELEC approved). An explosion or fire may result.
- Do not operate a radio unit that has been approved as intrinsically safe product in a hazardous atmosphere if it has been physically damaged (for example, cracked housing). An explosion or fire may result.
- Do not replace or charge batteries in a hazardous atmosphere. Contact sparking may occur while installing or removing batteries and cause an explosion or fire.

7. Warnings for Radios Approved as Intrinsically Safe

Radios must ship from the manufacturing facility with the hazardous atmosphere capability and the intrinsic safety approval labeling (FM, UL, CSA, and GENELEC). Radios will not be upgraded to this capability and labeled once they have been shipped to the field.

A modification changes the unit's hardware from its original design configuration.

Modifications can only be made by the original product manufacturer.



CAUTION:

- Do not replace or change accessories in a hazardous atmosphere. Contact sparking may occur while installing or removing accessories and cause an explosion or fire.
- Turn the radio off before removing or installing a battery or accessory.
- Do not disassemble an intrinsically safe product in any way that exposes the internal circuits of the unit.
- Failure to use an intrinsically safe approved battery or Approved accessories specifically approved for the radio unit may result in the dangerously unsafe condition of an unapproved radio combination being used in a hazardous location.
- Unauthorized or incorrect modification of the intrinsically safe approved Product will negate the approval rating of the product.
- Incorrect repair or relabeling of any intrinsically safe Agency approved radio could adversely affect the Approval rating of the unit.
- Use of a radio that is not intrinsically safe in a hazardous atmosphere could result in serious injury or death.

Part F: WARRANTY AND SAFETY INFORMATION

8. Repair



CAUTION:

REPAIRS FOR UNICATION U3 PRODUCTS WITH INTRINSICALLY SAFE APPROVAL ARE THE RESPONSIBILITY OF THE USER.

Repairs to an UNICATION U3 FM approved radio product should only be done at a location that has been FM audited under the FM 3605 repairs and service standard.

Contact Manufacturer for assistance regarding repairs and service of intrinsically safe equipment.

A repair constitutes something done internally to the unit that would bring it back to its original condition.

Do Not Substitute Options or Accessories

The UNICATION U3 communications equipment certified as intrinsically safe by the approving agency, (FM, UL, CSA, CENELEC) is tested as a complete system which consists of the listed agency Approved portable, Approved battery, and Approved accessories or options, or both. This Approved portable and battery combination must be strictly observed. There must be no substitution of items, even if the substitute has been previously approved with a different UNICATION U3 communications equipment unit. Approved configurations are listed by the Approving Agency (FM, UL, CSA, and CENELEC).

The Intrinsically Safe Approval Label affixed to radio refers to the intrinsically safe classification of that radio product, and the approved batteries that can be used with that system.

The manual PN referenced on the Intrinsically Safe Approval Label identifies the approved Accessories and or options that can be used with that portable radio unit.

Using a non-UNICATION U3 intrinsically safe battery and or an accessory with the UNICATION U3 approved radio unit will void the intrinsically safe approval of that radio unit.

Please visit

<http://www.unication.com>

or your local dealer for warranty clauses and further service.

Unication

UM-U3-ENG-V0.07b



Corporate Headquarter

Unication Co., Ltd.
Address: 5F, No.6, Wu-Kung 5Rd.,
Hsinchuang City., New Taipei, Taiwan.
+886-2-22999678
salesenquiry@uni.com.tw
www.uni.com.tw

Unication Dallas

1901 E. Lamar Blvd.
Arlington TX 76006
Kirk Alland
sales@unication.com
817-303-9320